

Tools Required

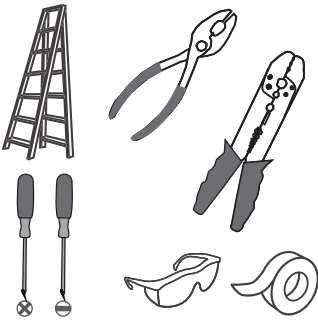

Light Source



LED G9 4.5W Bulb

3 BULBS REQUIRED INCLUDED

Warnings and Cautions

Turn off the electricity at the circuit breaker before installation. Consult a licensed electrician if in doubt about installation.

Turn off power to the fixture and allow the bulbs to cool before replacing.

Package Contents

Preparation: Identify and inspect all parts before beginning the installation.

Missing or damaged parts? Contact your original place of purchase.

PARTS BAG

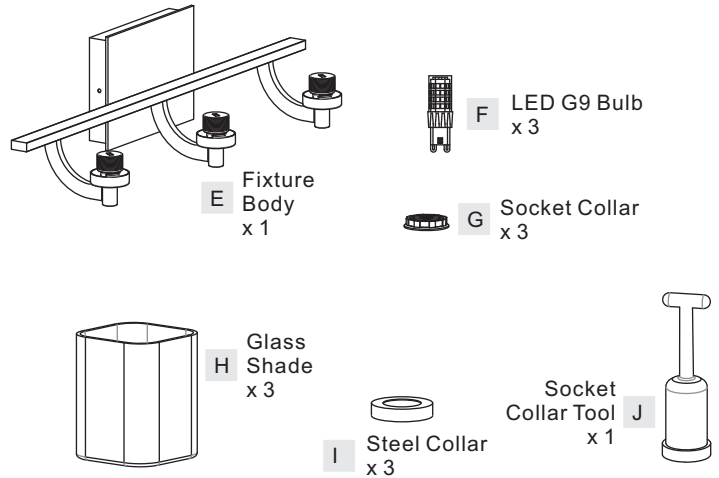
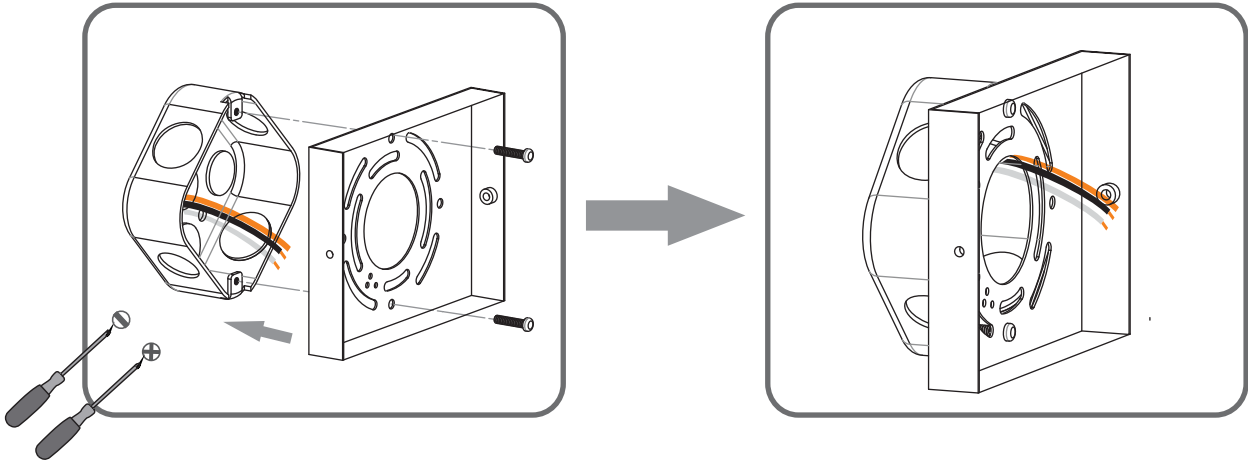

Table of Contents

Inner Backplate	Wiring	Fixture Body	Shade & Bulb
STEP 1	STEP 2	STEP 3	STEP 4

STEP 1



STEP 2

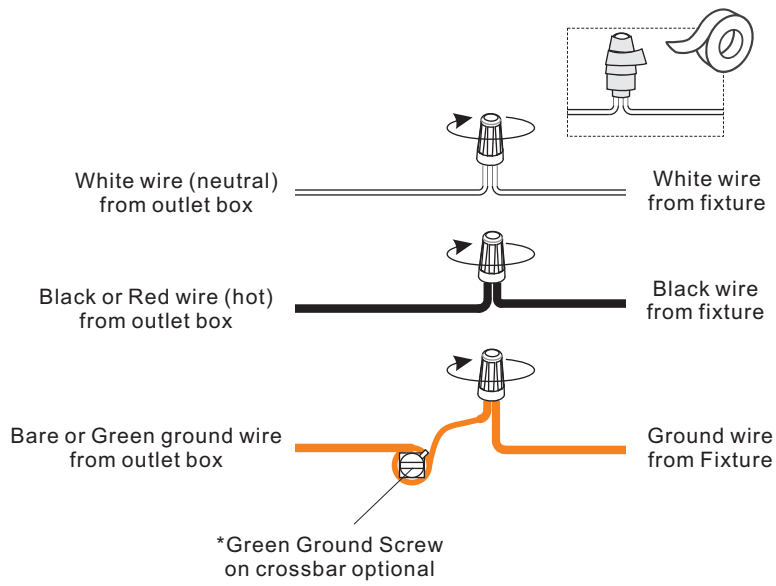

STEP 3

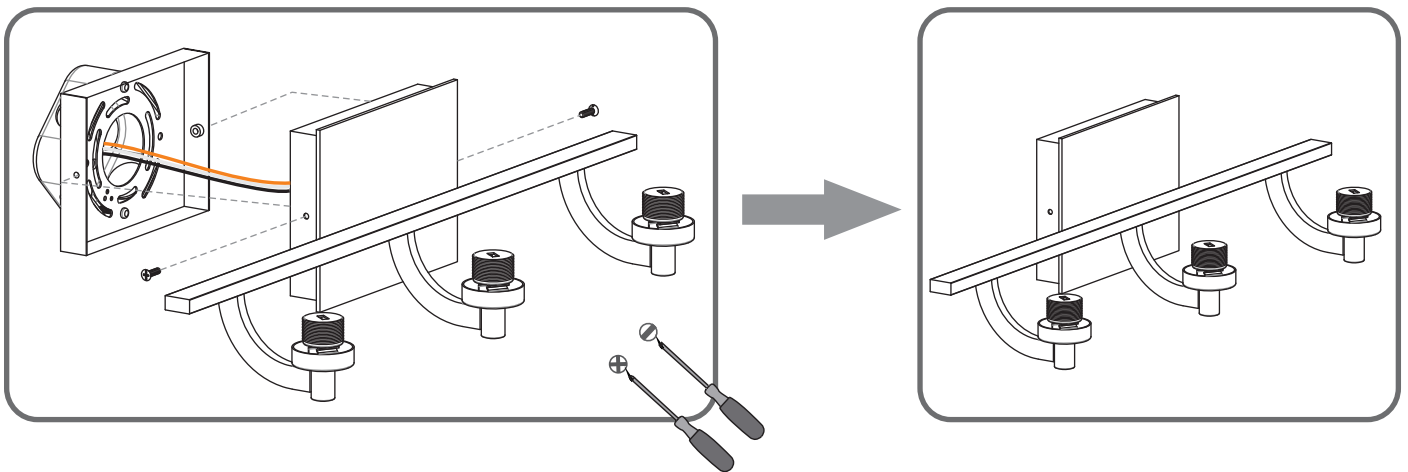

STEP 4

