

Please go to www. quoizel. com for product cleaning tips. Go to the **Care + Maintenance** selection.

Tools Required: Flathead screwdriver, Phillips screwdriver, pliers, wire cutters, wire strippers, electrical tape, safety glasses.

Light Source: (3) Medium Base Bulbs 100W Maximum

Estimated Assembly Time: 20-30 minutes

Preparation: Identify and inspect all parts before beginning installation. Check package content list and diagrams below to be sure all parts are present. If any parts are missing or damaged, do not attempt to assemble, install, or operate the fixture. Contact customer service for replacement parts.

⚠ Warnings and Cautions

Turn off electricity at circuit breaker or main fuse box before installation. Consult a licensed electrician if in doubt.

These instructions are provided for your safety. It is very important you read them completely before installing the fixture. We strongly recommend that a licensed, professional electrician perform the installation.

Disconnect fixture from power source before replacing bulbs. Make sure bulbs are given sufficient time to cool before removal.

Package Contents

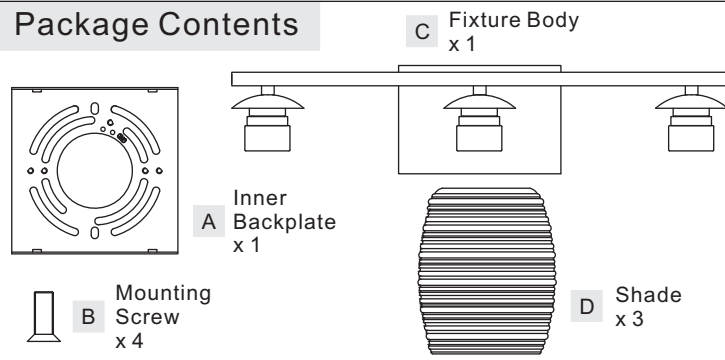

(Step 2 Continued)

B. Use standard wire connectors (not included) to make all wire connections. Twist connectors until wires are tightly joined together. Wrap each connection with approved electrical tape and carefully stuff all the connected wires into the Outlet Box.

STEP 3 - Install Fixture Body

A. Attach the Fixture Body (C) over the Inner Backplate (A) and secure with Mounting Screws (B). Tighten until snug with screwdrivers.

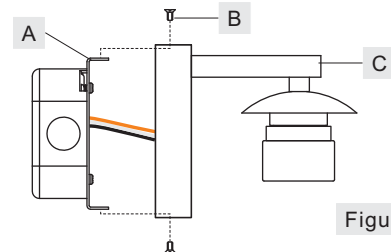

STEP 1 - Install Inner Backplate

A. Pass the supply wires and ground wire through Inner Backplate (A). Attach Inner Backplate (A) to Outlet Box with the head of Green Ground Screw facing you. Secure it with Outlet Box Screws (not included). Tighten until snug.

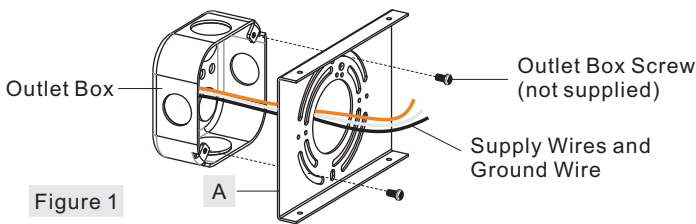

STEP 4 - Install Shades and Bulbs

A. Remove socket collars and metal rings from sockets.
 B. Place Shades (D) and metal rings over sockets and secure with previously removed socket collars. Hand tighten until snug.
 C. Insert bulbs onto sockets and screw snugly into place.

Your fixture is now assembled and ready to use. Enjoy!

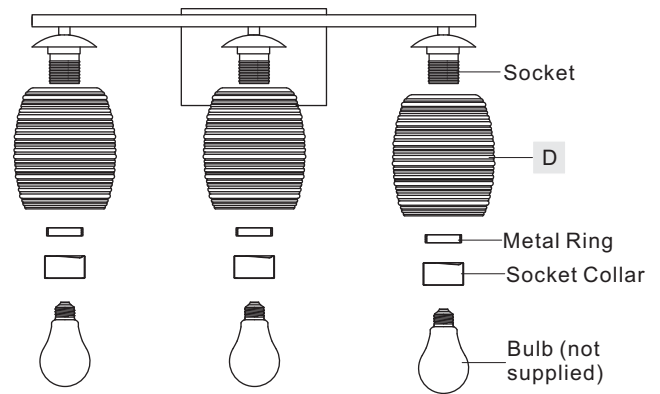

STEP 2 - Wire Connections

A. Wrap bare or green ground wire around green ground screw on the crossbar, no less than 2 inches from the end of the wire. Tighten the green ground screw.

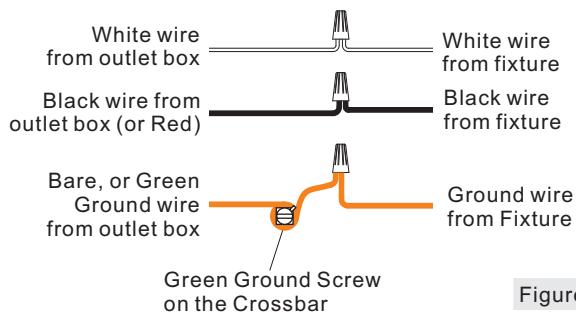

Thank you for purchasing a Quoizel product.
Need assistance with parts or assembly? Call Quoizel customer service at 1-800-645-3184
or visit us on-line at www. quoizel. com

RLM8603C

FINISH: POLISHED CHROME

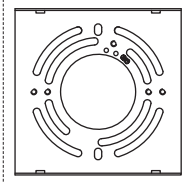

NOTE: ALL DIMENSIONS ARE ROUNDED UP TO THE NEAREST 1/4"

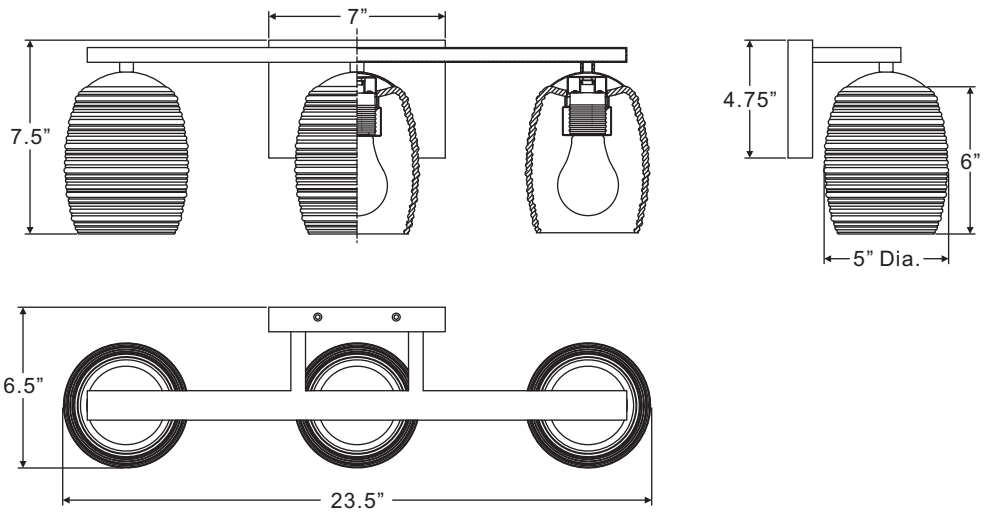

Thank you for purchasing a Quoizel product.
Need assistance with parts or assembly? Call Quoizel customer service at 1-800-645-3184
or visit us on-line at www.quoizel.com